



User Manual

HDP903 video processor & Splicer

V1.0 20200226

Safety Instructions

This symbol prompts the user, the device user manual has important operating and maintenance instructions. This symbol warns the user of the equipment inside the enclosure exposed to hazardous voltages, there is the risk of electric shock.

Note

Read the manual • Read and understand all safety and operating instructions before using the equipment.

Save the manual • The safety instructions should be kept for future reference.

Follow Warnings • Follow all warnings and instructions marked on the equipment or in the user information.

Avoid Attachments • Do not use tools or attachments that are not recommended by the equipment manufacturer because they may be hazardous.

Warning

Power sources • This equipment should be operated only from the power source indicated on the product. This equipment is intended to be used with a main power system with a grounded (neutral) conductor. The third (grounding) pin is a safety feature, do not attempt to bypass or disable it.

Power disconnection • To remove power from the equipment safely, remove all power cords from the rear of the equipment, or the desktop power module (if detachable), or from the power source receptacle (wall plug).

Power cord protection • Power cords should be routed so that they are not likely to be stepped on or pinched by items placed upon or against them.

Servicing • Refer all servicing to qualified service personnel. To prevent the risk of shock, do not attempt to service this equipment yourself because opening or removing covers may expose you to dangerous voltage or other hazards.

Slots and openings • If the equipment has slots or holes in the enclosure, these are provided to prevent overheating of sensitive components inside. These openings must never be blocked by other objects.

Statement

This document is intended to help you understand and use the product. For accuracy and reliability, our company may make improvements and changes to this document at any time and without notice. Any problem in use or any good suggestion, please contact us through ways provided in the document. We will do our utmost to solve the problems and adopt the suggestions after evaluation as soon as possible.

Trademarks

VGA and XGA are registered trademarks of IBM Corporation.

VESA is a trademark of the Video Electronics Standards Association.

HDMI logo and High-Definition Multimedia Interface (High-Definition Multimedia Digital Interface) are HDMI Licensing LLC. Trademarks.

Contents

Chapter 1 Overview.....	4
Chapter 2 Appearance.....	5
1.Front Panel.....	5
2.Rear Panel.....	6
Chapter 3 Menu Operations.....	7
1.System Architecture.....	7
2. Quick setup wizard.....	8
3. Layer setup.....	10
4. Preset recall.....	11
5. Splice.....	11
6. Specification.....	13

Chapter 1 Overview

This is a high-end 4K x 2K@60Hz splicing processor, 4-channel multi-graphic multi-input splicing processor, it can input four 4Kx2K images at the same time, and any 4Kx2K images can be arbitrarily zoomed by any roaming of images, meet ultra high definition display requirements.

The output supports customized resolution, each single channel support 2.65 million points and 4 channels could support up to 10.6 million points of output. The maximum single splicing is 4608×2304 or 9216×1152 or 4096×2304 or 1920×4800.

Intelligent splicing support, the uses many of setup wizards for the menu, and the first time users can quickly complete the operation.

The can accommodate a wide range of input sources, up to 2 HDMI-4K, 2 DP-4K, and support for SDI input. 4-channel independent image processing engine with 4 channels of fully configurable inputs for optional selection of 4 inputs to the LED screen.

The splicing processor is more user-friendly and easier to use with powerful features.

Simply use the button panel and menu system to complete complex settings. Full setup and operation is possible with the front buttons and RS-232 and USB. The physical interfaces provided are rich enough to meet the needs of common output devices.

Provides installation locations for up to 4 LED sending cards, simplifying installation.

Chapter 2 Appearance

1. Front Panel

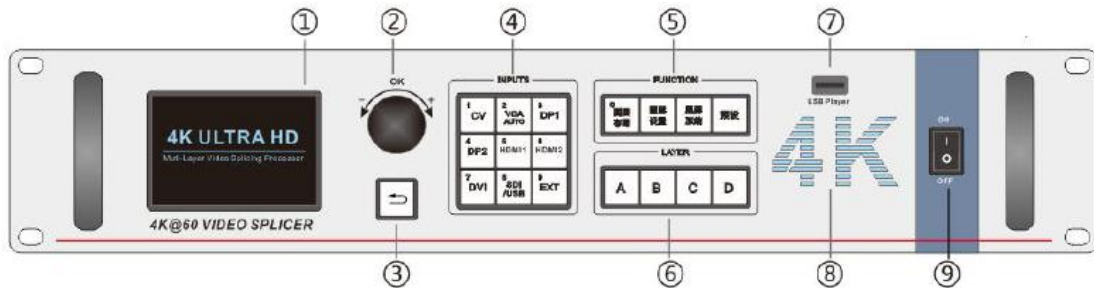

① LCD display, Display the menu and parameters of configuration.

② Knob button

- Rotate the knob to select the menu or adjust the parameters
- Press the knob to enter the menu or confirm the operations

③ Return button ,Exit from current menu or operation.

④ Input button

Select the input source signal for current layer.

- The indicator light keep flashing if the selected input no signal.
- The indicator light keep bright if the selected input is signaled.

⑤ Function button

- Layer Style, there are 8 styles for selection.
- Layer Setting, set the position, size, rotation of selected layer.
- Black/Freeze, black or freeze function button.
- Load, load the preset.

⑥ Layer button ,Layer selection button, the configuration based on layer.

⑦ USB interface ,Use for play video from external USB.

⑧ 4K logo ,Blue light 4K logo with breathing effect, turn off in the menu.

⑨ A/C switcher ,A/C power supply switcher.

2.Rear Panel

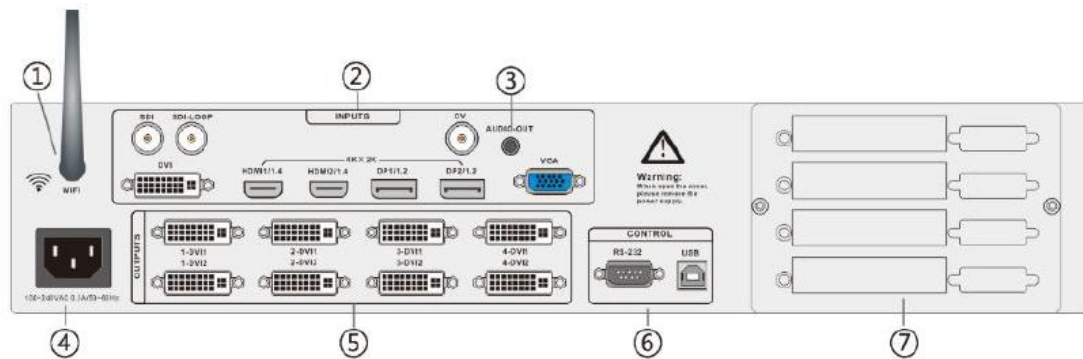

- ① WIFI antenna Use for mobile phone and tablet to remote control the product.
- ② Input interface
HDMI1.4 x2 4K/30Hz;DP1.2 x2 4K/60Hz;DVI x1;VGA x1;SDI x1;SDI-LOOP x1;CV x1;
- ③ Audio output 3.5mm coaxial audio output.
- ④ Power interface 100 ~ 220VAC input.
- ⑤ DVI output DVI x8 four group output.
- ⑥ Control interface RS232, USB remote control.
- ⑦ Sending card slot 4 sending card slot.

Chapter 3 Menu Operations

1. System Architecture

The video processor has 8 digital-to-analog input, including CVBS x1, VGA x1, DVI x1, HDMI1.4 X1 ,DP1.2 x1, HDMI1.4 supports 3840x2160@30Hz, DP1.2 supports 3840x2160@60Hz. Any 4 screen input and roam freely, the single channel output supports customized resolution up to 2.65 megapixels. SDI and USB are optional input, the SDI and USB are mutually exclusive when the video processor works.

The signal input video processor, 4 layers can accept any input signal, the size and position of the layer can be adjusted arbitrarily, the configured signal source output to 4 groups of DVI, so the signals of each group DVI are the same. The output signals can be displayed separately on each DVI output or together with multiple DVI groups splicing.

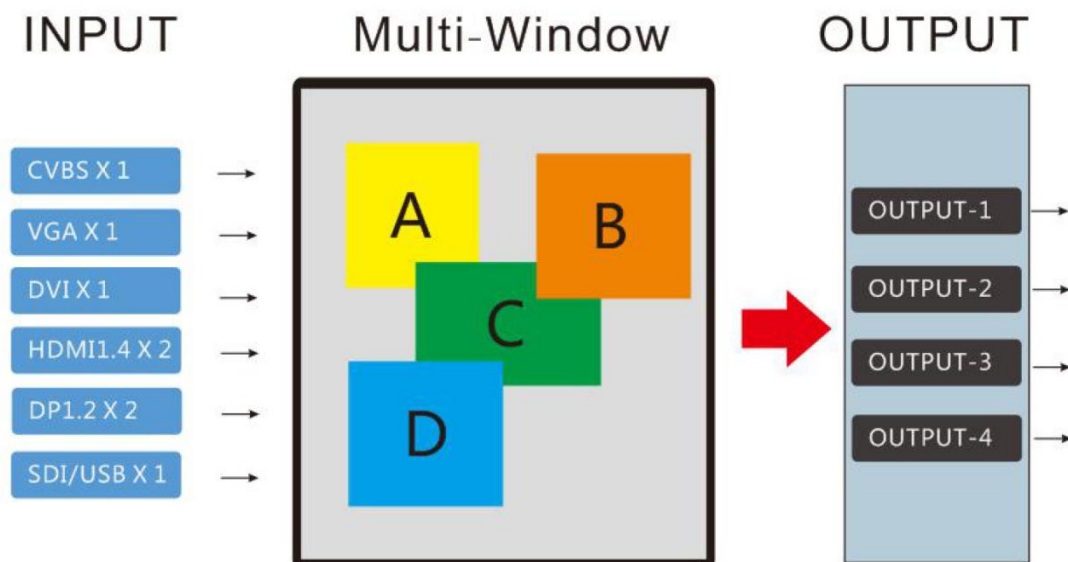

Tips: when the source is selected, it is operated for the layer and is independent of the output

After startup, the OLED screen on the front panel is shown the default menu as below:

Layer Source	splicer	
Layer A	DVI	1920x1080 60
Layer B	DP1	3840x2160 60
Layer C	HDMI1	3840x2160 30
Layer D	VGA	1920x1080 60

In the default menu, press the knob to enter the main menu, press knob continue to enter the sub-menu, press return button to back to previous menu, rotate the knob left and right to choose wanted menu item.

The main menu is shown as the following figure,

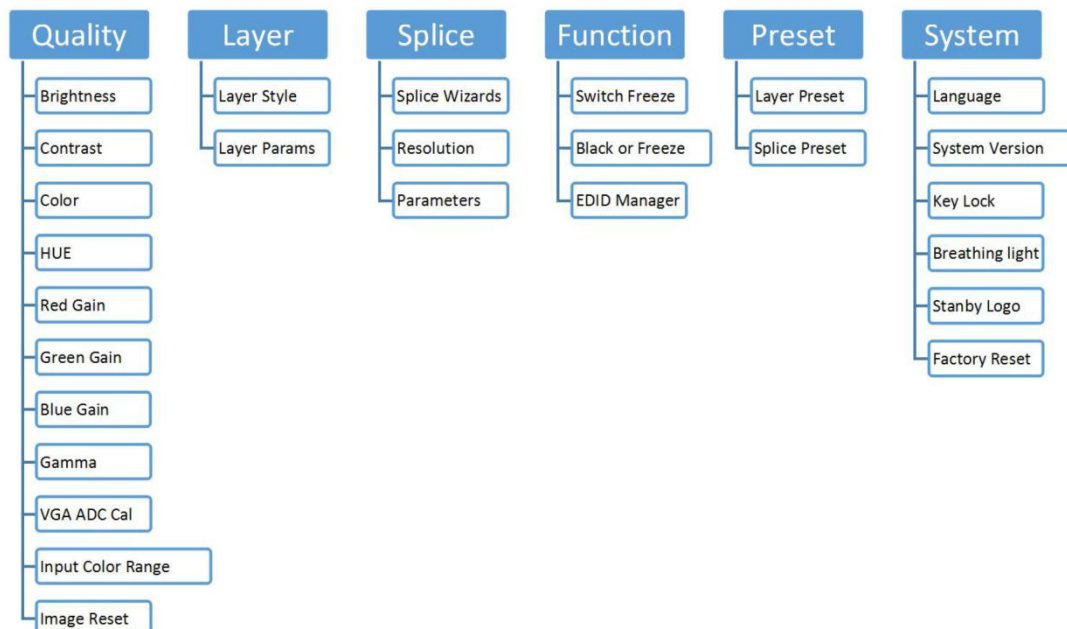

2. Quick setup wizard

Wizard function enables quick setup of product parameters and enhanced product usability. After the factory reset the wizard will pop up automatically or enable the wizard function from "" menu.

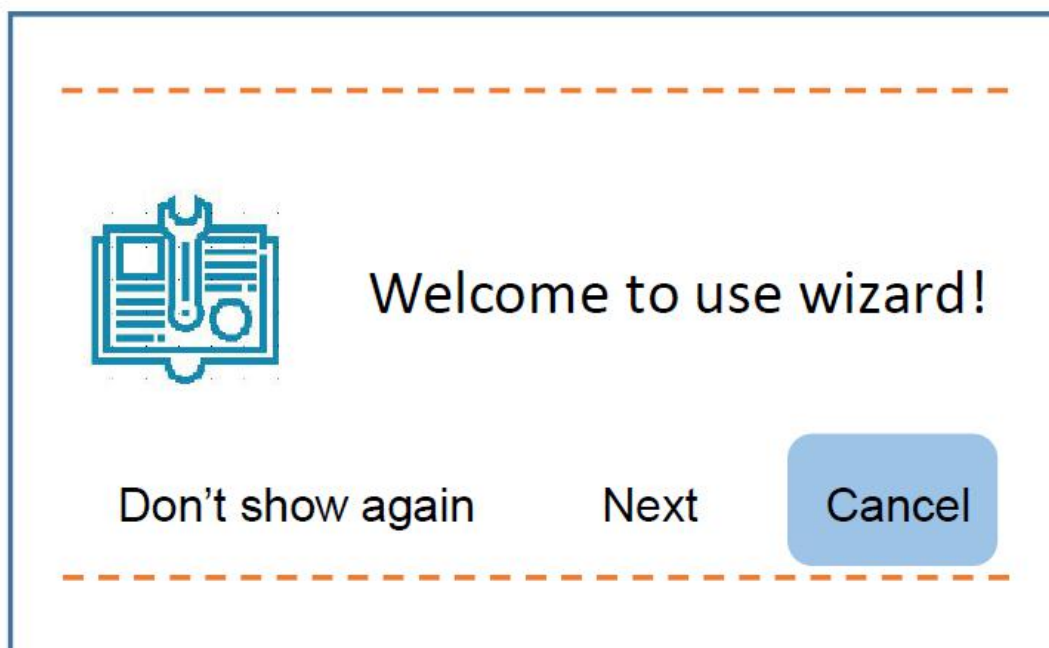

Setp1, Setting Resolution

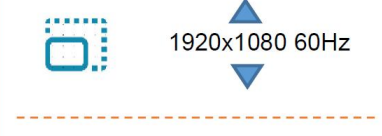

1920x1080 60Hz

Set a resolution that is greater than or equal to the maximum resolution of the output channel. Press OK and all DVI will output the same resolution.

Setp2, Setting Splice Mode

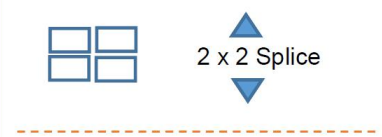

2 x 2 Splice

Select the splicing model according to the led screen, "2x2", "1x4" etc, also support customized model.

Step3, Setting Led Parameter



Total Size_H 3840
Total Size_V 2160
Next

Enter the total horizontal and vertical resolution of the LED screen.

Setp4, Setting Splice Parameters

Out1_x	0	Out2_X	1920
Out1_Y	0	Out2_Y	0
Out3_X	0	Out4_X	1920
Out3_Y	1080	Out4_Y	1080

The output channels are 1, 2, 3 and 4, the X, Y splicing starting coordinate of each channel can be adjusted by the user.

Setp5, Setting Layer Style

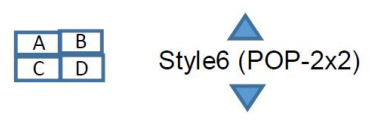

Style6 (POP-2x2)

Select the layers layout style, provide eight layout styles, users can also define the style of the layers.

3. Layer setup

The multi-screen video splicing processor has 4 layers, and each layer can be configured with parameters, such as input source, layer switch, position, size, rotation mode, and layer layout. The layers button is arrayed on the front panel.

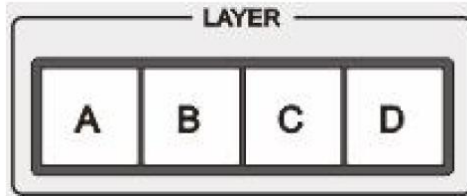

The layer must be selected before the operation, and the layer should be in the enabled status. If the layer is disabled, please enable the layer in the layer settings.

1) Input source

Press the layer indication button on the front panel, then press the input indication button which array in "INPUTS" area on the front panel, for example, set the input of layer B to DP1.

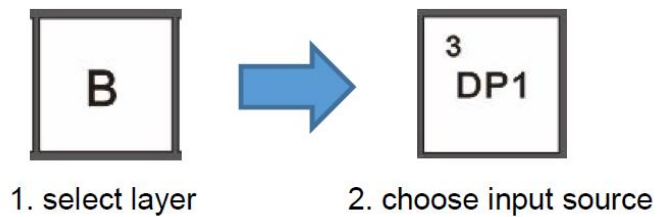

2) Layer layout

This video processor provides 8 different layer layouts that users can choose based on their specific needs.

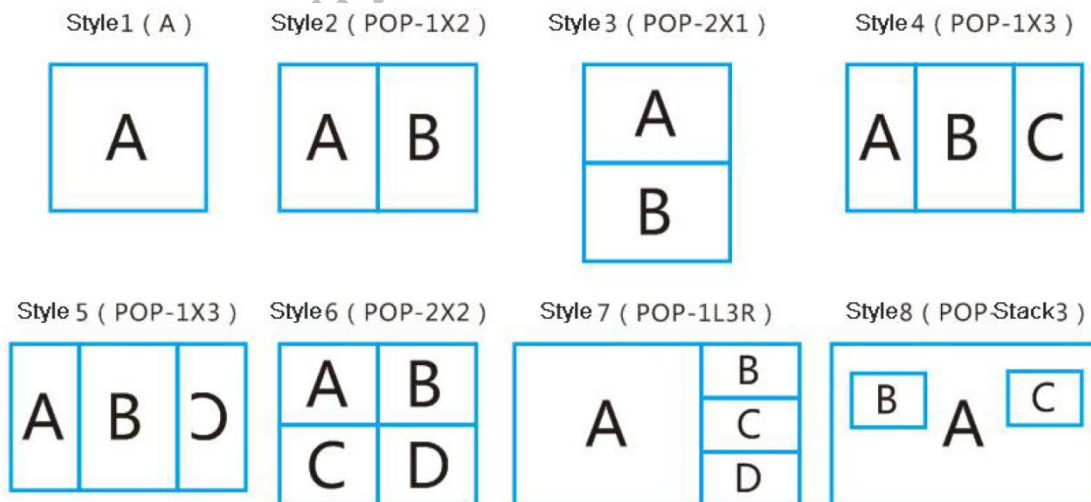

3) Layer setting

You can set various parameters for all layers, including layer on/off, layer flips, horizontal start, vertical start, horizontal width, and vertical height. When the preset parameters do not meet the requirements, the parameters of each layer can be adjusted separately.

Press the shortcut "Layer Settings" to enter the setup menu.

Layer Setting	
Layer	Layer_A
Layer enable	On
Layer rotate	0
H Pos	0
V Pos	0
H Size	3840
V Size	2160

4. Preset recall

Apply the preset parameters directly. 10 presets in total are available for users to set and use. When you enter the preset recall menu "Load", the indicators of number buttons on the front panel will turn on. You can press the number button to quickly load the corresponding preset.

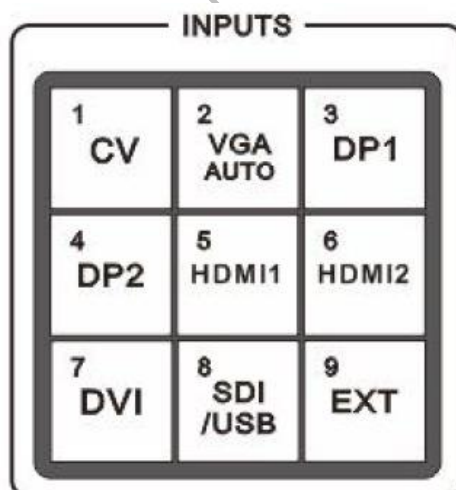

5. Splice

It is recommended to use the splicing wizard to complete the splicing quickly. If the splicing wizard does not meet the user's needs, do the following.

1) Set the output resolution (Menu: Splice -> Resolution>>>)

This resolution is set according to the one with the highest actual resolution among the 4 channels.

For example, the actual output resolution is

output 1: 1852x1216;

output2: 1728x1216;

output3:2048x1216;

output4: 1920x1216;

The resolution should be set to 2048x1216, or it can be larger than 2048x1216, as long as it does not exceed 2.6 megapixel. After setting, the resolution of output 1~4 is 2048x1216.

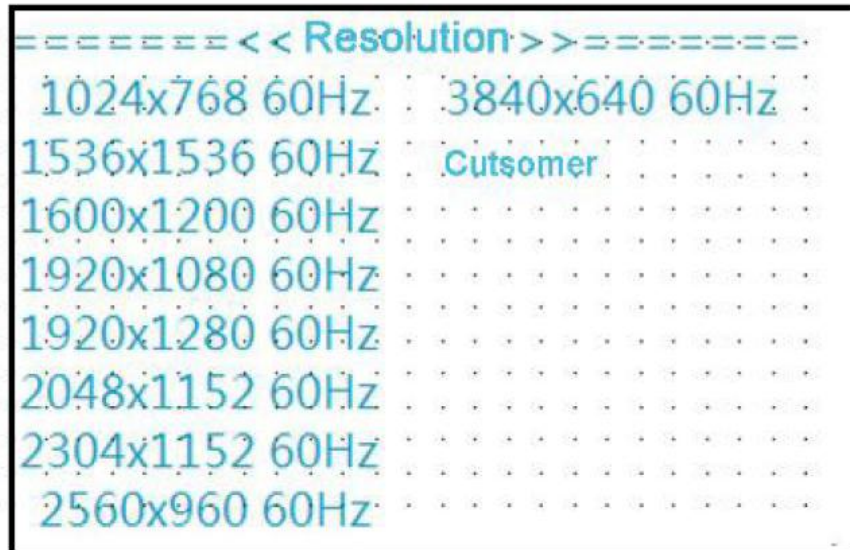

2) Set the splicing parameters _Menu: Splice ->Parameters>>>)

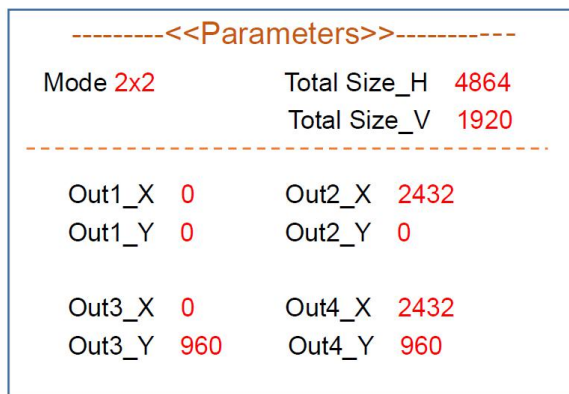

1. Select the splicing mode.
2. Set the horizontal and vertical total resolution of the LED screen.
3. Set the starting X/Y coordinate of each output channel.

6. Specification

DP Input	
Quantity	2
Connector	DP
Standard	DP1.2
Resolution	VESA, 3840 X 2160@60Hz, customized EDID
HDMI Input	
Quantity	2
Connector	HDMI
Standard	HDMI1.4
Resolution	VESA, 3840x2160@30Hz, 2560x1600@60Hz, customized EDID
DVI Input	
Quantity	1
Connector	DVI-I
Standard	DVI1.0,HDMI1.3
Resolution	1920x1200@60Hz, customized EDID
VGA Input	
Quantity	1
Connector	VGA-B15
Standard	R, G, B, Hsync, Vsync: 0 to1Vpp±3dB(0.7V Video+0.3v Sync)
Resolution	VESA, PC to 1920x1200
3G-SDI Input (optional)	
Quantity	1
Connector	BNC
Standard	SD-SDI, HD-SDI, 3G-SDI
Resolution	1080p 60/50/30/25/24/25(PsF)/24(PsF) 720p 60/50/25/24 1080i 1035i 625/525 line
CVBS(CV) Input	
Quantity	1
Connector	BNC
Standard	PAL/NTSC 1Vpp±3db (0.7V Video+0.3v Sync) 75 ohm
Resolution	480i,576i
DVI Output	
Quantity	4 Channels-DVI x 8
Connector	DVI-I
Standard	DVI: DVI1.0
Resolution	1024×768@60Hz 2048×1152@60Hz 1536×1536@60Hz 2304×1152@60Hz 1600×1200@60Hz 2560×960@60Hz 1920×1080@60Hz 3840×640@60Hz 1920×1280@60Hz
	Customized resolution Single output: 2.65 megapixel@60Hz Four channels: 10.6megapixel@60Hz
Parameters	
Weight	6.5kg
Size(mm)	Product: (L x W x H) 335 x 440 x 88 Package: (L x W x H) 540 x 450 x 190
Input voltage	AC 100V-240V50/60Hz /100W ; Product Power: 26W
Model	(standard)/(SDI input)