



PRODUCT SPECIFICATION

产品规格书

LCD controller——HD-40S

V1.0

深圳市灰度科技有限公司

Shenzhen Huidu Technology Co., Ltd.

目录 Contents

01	Chapter I Product Description.....3	
	I . Overview.....3	
	II. Features.....3	
02	Chapter II Product Specifications..... 4	
	I . Basic Parameters.....4	
	1. Hardware parameters.....4	
	2. Software Parameters.....5	
	II. Dimension Diagram.....6	
	III. Product Diagram.....7	
	IV. Interface parameter description.....7	
	1. PWR/DC (Power input) interface.....7	
	2. MIC (Microphone) interface and definition.....8	
	3. IR-LED (Remote control) interface and definition.....8	
	4. LVDS BL (LVDS backlight) Interface.....9	
	5. LVDS interface and definition.....10	
	6. USB interface and definition.....11	
	7. SPK (Power amplifier) interface.....11	
	8. L/R (Audio and definition).....12	
	9. KEY interface (Extend) definition.....12	
	10. UART (Serial Port) Interface *4.....13	
	11. DEBUG Interface.....13	
	12. 4PIN RJ45 (Ethernet Port)14	
	13. Other Interface.....14	
03	Chapter III Communication Methods..... 15	
	I . Wi-Fi Update Program.....15	
	II. U disk Update Program.....15	
	III. TF card Update Program.....16	
	IV. Network Cable Update Program.....16	
	V . Internet Update.....17	
04	Chapter IV Appendix: Product Appearance..... 18	

Chapter I Product Description

I. Overview

HD-40S is a well-built all-in-one motherboard, using Allwinner A40i Quad-core chip solution, equipped with Android7.1.1 system, 1.2GHz, Mail-400MP2 GPU, with very strong video processing capabilities, compatible with most Video format and decoding capabilities. It supports IR control, Wi-Fi, RJ45 and other rich interfaces, making the product more versatile, and is widely used in advertising machines, interactive all-in-one machines, security, medical, transportation, finance, industrial control and other intelligent control fields, which can accelerate Product development cycle.

Due to its hardware platform and Android intelligent features, it can be used on the smart terminal motherboard when human-computer interaction or network device interaction is required, which can be your best choice

II. Features

- Minimalist design, reserved common interfaces, Mini size, can be used in ultra-thin application scenarios;
- High stability. The A40i Android integrated board adds its own unique technology to the hardware and software to ensure the stability of the product, which can make the final product reach 7*24 hours unattended.
- High integration. The A40i Android all-in-one board integrates Ethernet, Wi-Fi, Power amplifier, TF expansion card, USB expansion port, IR remote control function, HDMI, LVDS, Backlight control, microphone and other functions, which greatly simplifies the design of the whole machine.
- High scalability. 6*USB (4 *Pins, 2 *standard), 5 *serial ports (4 *UART, 1 *DEBUG), and 5 *IO expansion ports available expand more peripheral devices.
- High definition. It supports various LVDS/HDMI interface LCD displays, and supports various sizes and resolutions of cropped screens.
- Perfectly support multiple mainstream touch screen functions such as multi-point infrared touch, multi-point capacitive touch, multi-point Nano film touch, multi-point acoustic wave touch, multi-point optical touch, etc.

Chapter II Product Specifications

I. Basic Parameters

1. Hardware Parameters

Hardware Specifications

CPU	A40i, Quad-core, Dominant Frequency up to 1.2GHz, Android7.1.1
GPU	Mali400 MP2
Memory	1GB
Built-in storage capacity	eMMC Default 16 GB TF Card Extend(Extendable SSD)
Network	RJ45 100M; Ethernet; Wi-Fi, support Wi-Fi 802.11b/g/n protocol
Display interface	1*LVDS interface (single/dual, 6-bit/8-bit), support 3.3V/5V/12V power supply Onboard backlight control supports 12V backlight power supply
Image rotation	Support 0°, 90°, 180°, 270° or manual rotation, optional gravity sensor module to achieve automatic rotation.
Audio	Support standard left & right channel line output; support 3.5mm audio output interface
Power amplifier	2 outputs (8 ohms, 5 watts dual audio amplifier output)
Microphone	Differential MIC input
Touch screen	Support USB multi-point infrared touch, multi-point capacitive touch, multi-point nano film touch, multi-point sound wave Touch, multi-point optical touch and so on
RTC	Built-in real-time clock function
USB	1 *USB-2.0 HOST , 1* USB2.0 OTG, 4 *Expansion USB
IR	Infrared receiver, support infrared remote control function
LED	1* Power Status LED (green), 1* System LED (green blinking in default)
Button	1*Upgrade key
Serial port	4 *UART, 1 *DEBUG
IO Port	5 *IO input/output, Available key scanning control
Power adapter	Input: AC100-240V.50-60HZ, Output: DC12V 1.5A (Requires surge voltage less than 18V, ripple voltage less than 100mV)
Storage humidity	10% ~ 90% RH
Storage temperature	-40°C~70°C
Operating temperature	-20°C~70°C

2. Software Parameters

Software Specifications

Operating System	Android 7.1.1
Audio	MP3,WMA,WAV, APE, FLAC, AAC, OGG,M4A,3GPP and other formats
Video	Support AVI, rm, rmvb, MKV, WMV, MOV, MP4, DAT, PMP, MPEG, MPG, FLV, ASF, TS, TP, 3GP, MPG and other formats
Image	Support JPG、BMP、PNG and various images formats
System Comes with Application Software	APK Installer, Email, Calculator, Browser, Recorder, Calendar, Settings, Clock, Video Player, Search, Contacts, Gallery, Download, Camera, Music, Explorer, etc.
Language	support multi-language
Input method	Standard Android keyboard with optional third-party input method
System Management	Original ecological Android system, open root permissions, and can customize product development
	Real-time remote monitoring, system crash self-recovery, unattended 7 * 24 hours
	Support OTA remote upgrade; support U-disk upgrade
	Support boot animation definition
System Watchdog	Support server / stand-alone mode switching
	Support Wi-Fi hotspot
	Support software watchdog

II. Dimension Diagram

1. Bare board Dimensions; (mm)

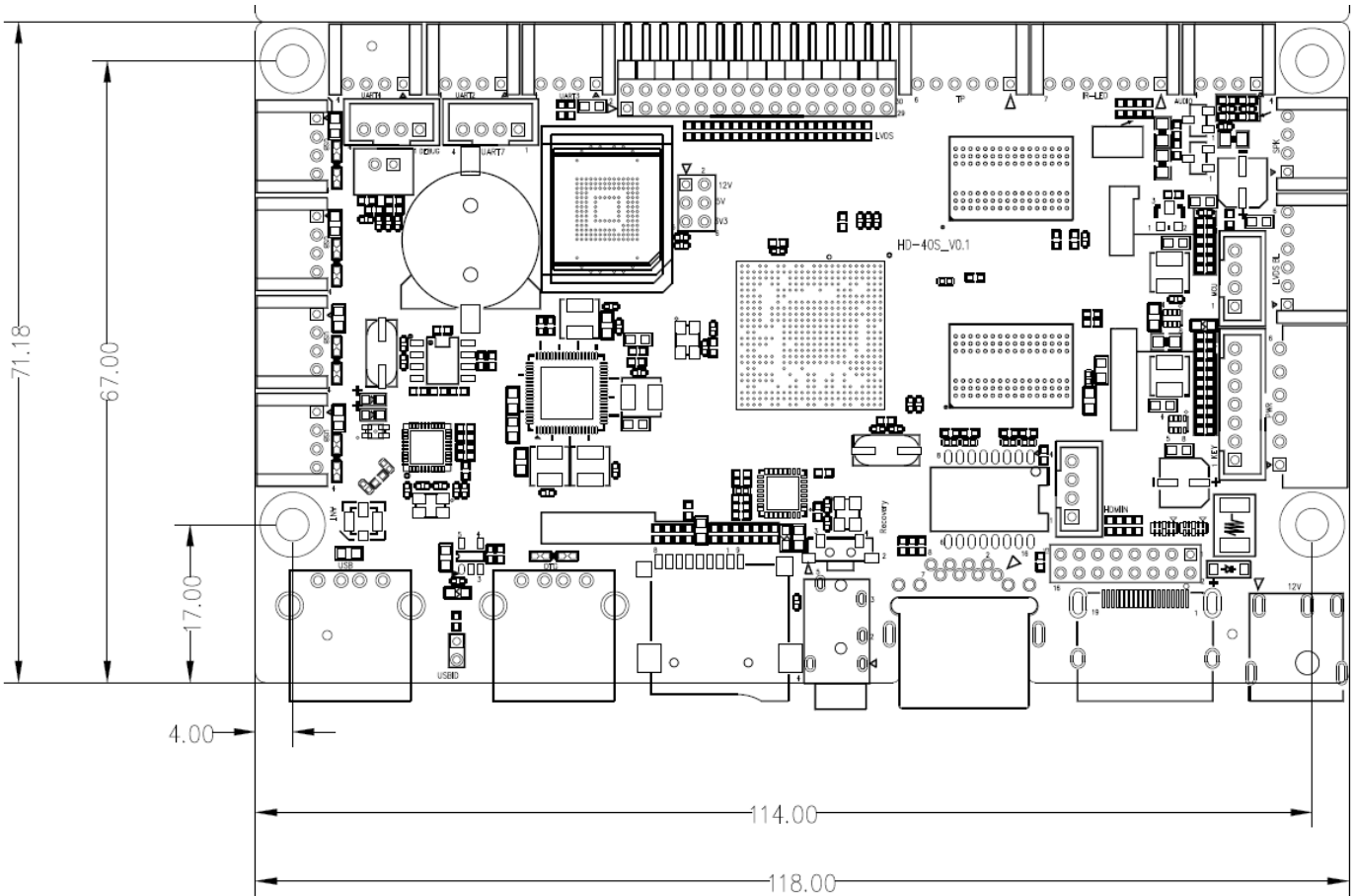

III. Product Diagram

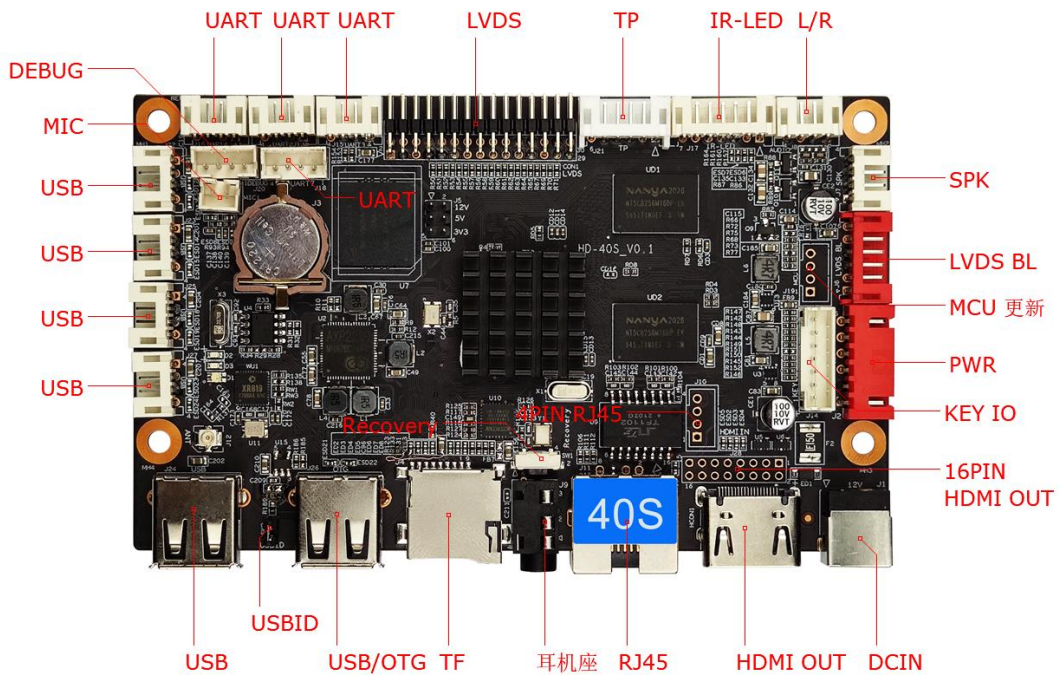

IV. Interface parameter description

1. PWR/DC (Power input) interface

It adopts 12V DC power supply and only allows the motherboard subsystem to be powered from the DC socket and power socket.

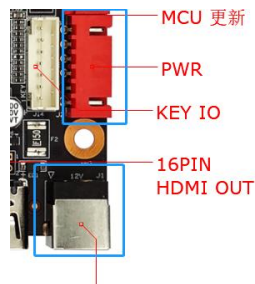

Serial number	Definition	Attributes	Describe
6	12V	input	12V input
5	12V	input	12V input
4	GND	GND	GND
3	GND	GND	GND
2	5VS	input	stand by 5V input
1	STB	output	stand by signal output

2. MIC (Microphone) interface and definition

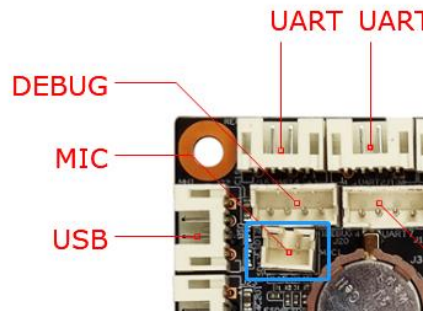

Serial number	Definition	Attributes	Describe
1	MIC-P	input	MIC+input
2	MIC-N	input	MIC-input

3. IR-LED (Remote control) interface and definition

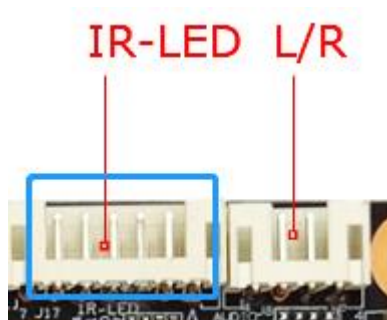

Serial number	Definition	Attributes	Describe
1	RED	output	red indicator lamp
2	5V	power supply	5V output
3	GRN	output	green indicator
4	IO	output	remote control signal output
5	IR	input	remote control signal input
6	GND	GND	GND
7	5V	power	5V output

4. LVDS BL (LVDS backlight) Interface

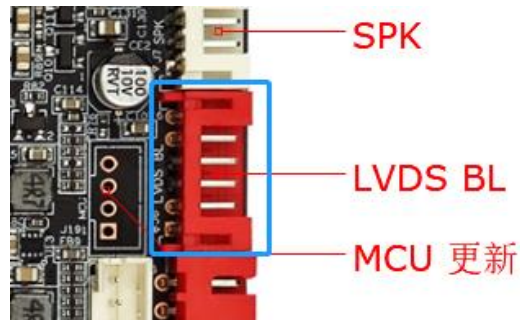

Serial number	Definition	Attributes	Describe
1	GND	GND	GND
2	GND	GND	GND
3	ADJ	output	backlight brightness control
4	EN	output	backlight brightness control
5	12V	power supply	12V output
6	12V	power supply	12V output

5. LVDS interface and definition

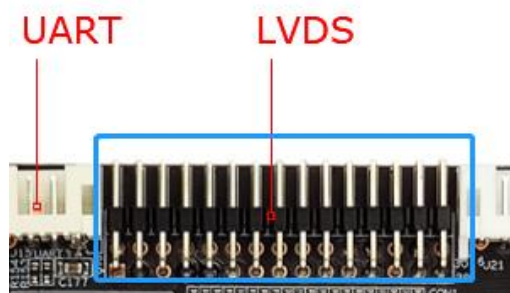

General LVDS interface definition, support single/dual, 6/8/10 bit 1080P LVDS screen. The screen voltage can be selected through the bridge-wire cap, and can choose to support 3.3V/5V/12V screen power supply.

In order to avoid burning the motherboards and screens, please pay attention to the following matters:

1. Please confirm whether the screen specification book screen supply voltage is correct, whether the board's corresponding power supply can meet the maximum working current of the screen.
2. Please use a multimeter to confirm that the power supply selected by the jumper cap is correct.
3. When connecting the 6 / 8-bit LVDS screen cable, install it near pin 1.

Serial number	Definition	Attributes	Describe
1	VCC	power supply	3.3V/5V/12V optional output
2	VCC		
3	VCC		
4	GND	ground wire	ground wire
5	GND	ground wire	ground wire
6	GND	ground wire	ground wire
7	RX00-	output	Odd 0 -
8	RX00+	output	Odd 0+
9	RX01-	output	Odd 1 -
10	RX01+	output	Odd 1+
11	RX02-	output	Odd 2 -
12	RX02+	output	Odd 2+
13	GND	ground wire	ground wire
14	GND	ground wire	ground wire
15	RXOC-	output	Odd Clock-
16	RXOC+	output	Odd Clock+
17	RX03-	output	Odd 3 -
18	RX03+	output	Odd 3+
19	RXE0-	output	Even 0 -
20	RXE0+	output	Even 0+
21	RXE1-	output	Even 1 -
22	RXE1+	output	Even 1+
23	RXE2-	output	Even 2 -
24	RXE2+	output	Even 2+
25	GND	ground wire	ground wire
26	GND	ground wire	ground wire
27	RXEC-	output	Even Clock -
28	RXEC+	output	Even Clock+
29	RXE3 -	output	Even 3 -
30	RXE3+	output	Even 3+

6. USB interface and definition



The motherboard has 2 USB standard interfaces and 4 USB pins

Serial number	Definition	Attributes	Describe
1	5V	power	5V output
2	DM	input/output	DM
3	DP	input/output	DP
4	GND	GND	GND

7. SPK (Power amplifier) interface

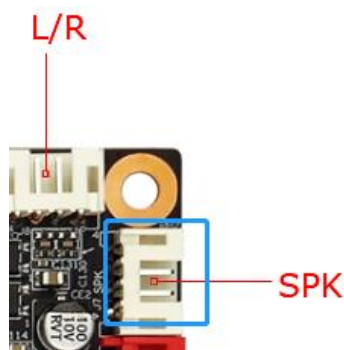

Serial number	Definition	Attributes	Describe
1	OUTP-R	output	right channel+
2	OUTN-R	output	right channel-
3	OUTN-L	output	left channel-
4	OUTP-L	output	left channel+

8. L/R (Audio and definition)

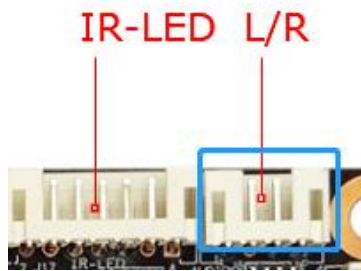

Serial number	Definition	Attributes	Describe
1	LO-L	output	left channel
2	LO-R	output	right channel
3	GND	GND	GND
4	NC	NC	undefined

9. KEY interface (Extend) definition

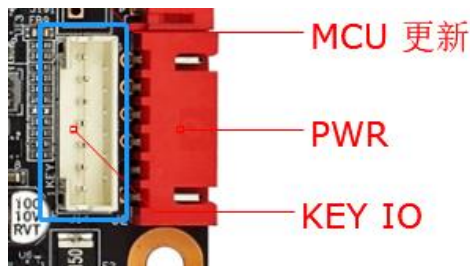

Serial number	Definition	Attributes	Describe
1	GND	GND	GND
2	K5	K5	K5
3	K4	K4	K4
4	K3	K3	K3
5	K2	K2	K2
6	K1	K1	K1
7	3V3	Power	3.3V Output

10. UART (Serial Port) Interface *4

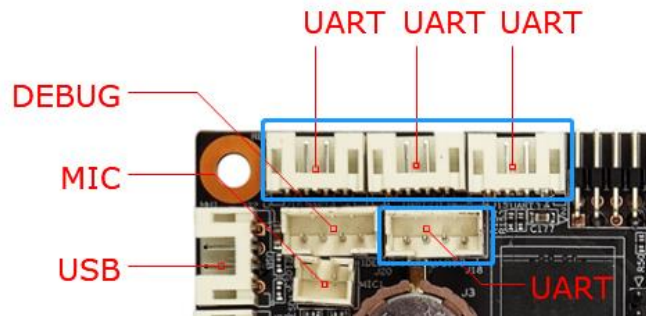

The motherboard leads to two sets of common UART serial ports, which can support common UART serial devices on the market.

Matters need attention:

1. Whether the TTL serial port voltage matches. Can not directly connect to MAX232,485 devices.
2. Whether the TX and RX connections are correct.

Serial number	Definition	Attributes	Describe
1	5V	power	5V output
2	TX	output	TX
3	RX	input	RX
4	GND	GND	GND

11. DEBUG Interface

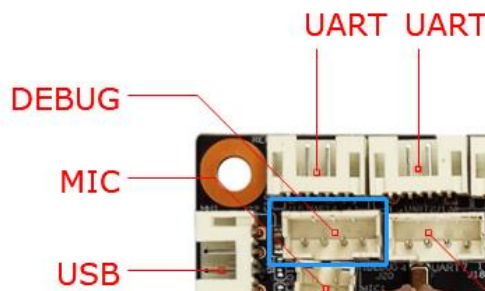

Serial number	Definition	Attributes	Describe
1	3V3	power	3.3V output
2	TX	output	TX
3	RX	input	RX
4	GND	GND	GND

12. 4PIN RJ45 (Ethernet Port)

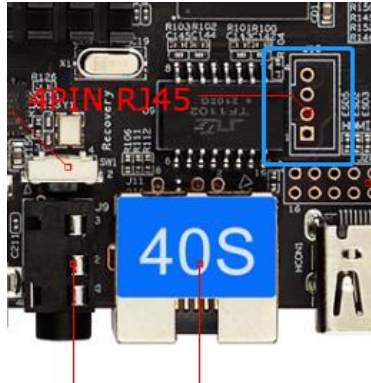

Serial number	Definition	Attributes	Describe
1	TX+	output	output+
2	TX-	output	output~
3	RX+	input	input+
4	RX-	input	input-

13. Other Interface

Storage interface	SD card	Data storage, maximum 32G
	USB	HOST interface, support Data storage, Data import, USB mouse and keyboard, camera, Touch screen, etc.
Ethernet interface	RJ45 Port	support 100M wired network
HDMI IN interface	standard interface	Support 1080P output

Chapter III Communication Methods

I. Wi-Fi Update Program

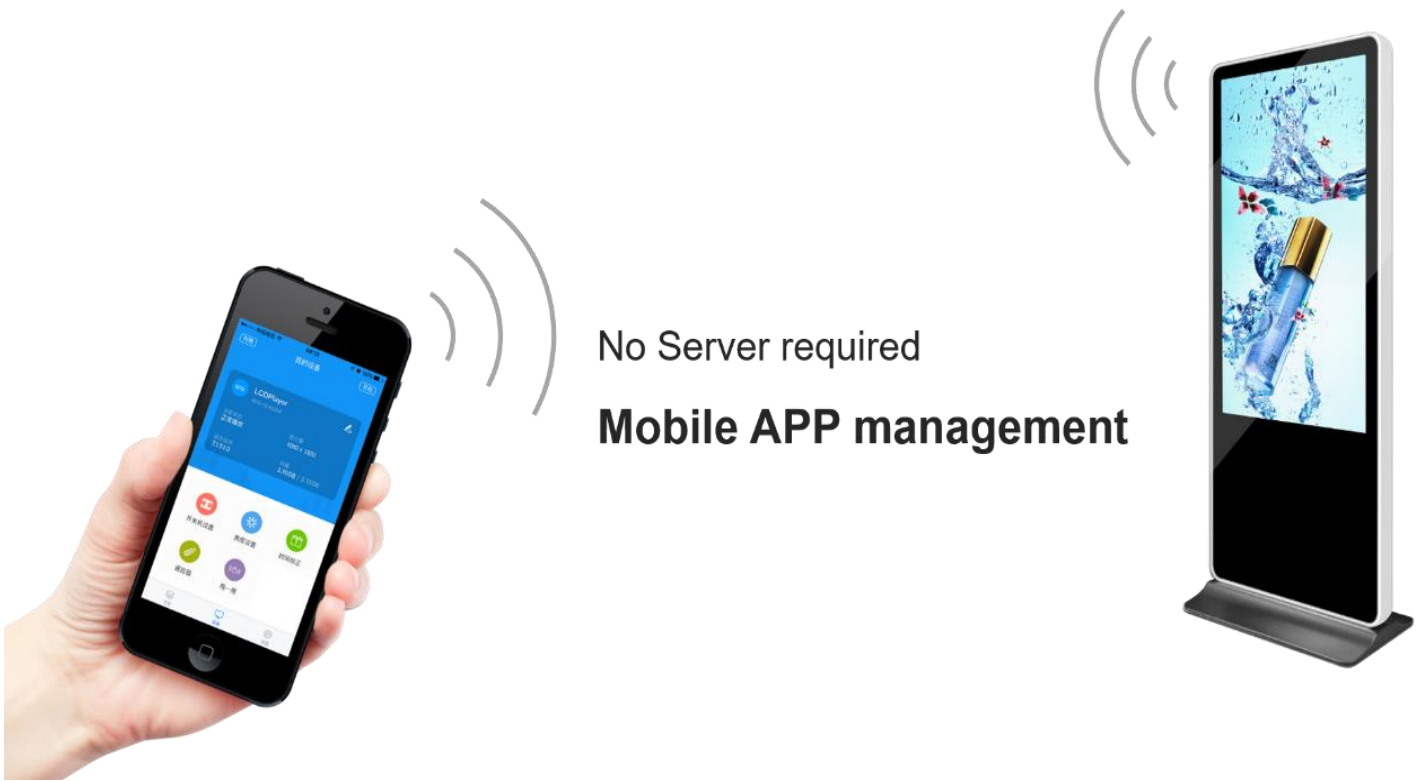

II. U disk Update Program

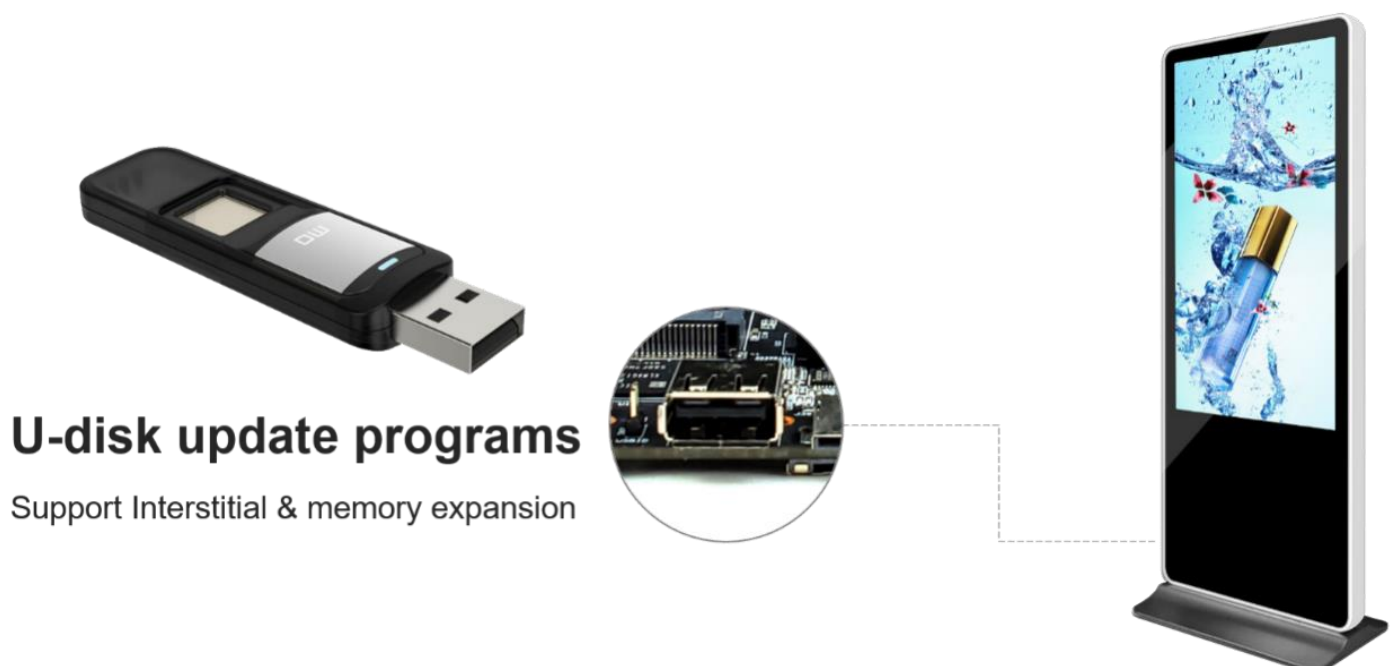

III. TF card Update Program



TF card update programs

Support Interstitial & memory expansion



IV. Network Cable Update Program

LAN or Internet

Network cable connection

LAN & Internet integrated management

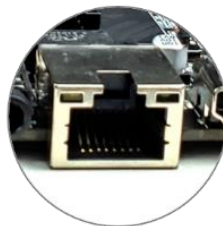

V. Internet Update

Internet remote management

Anytime & anywhere operation available

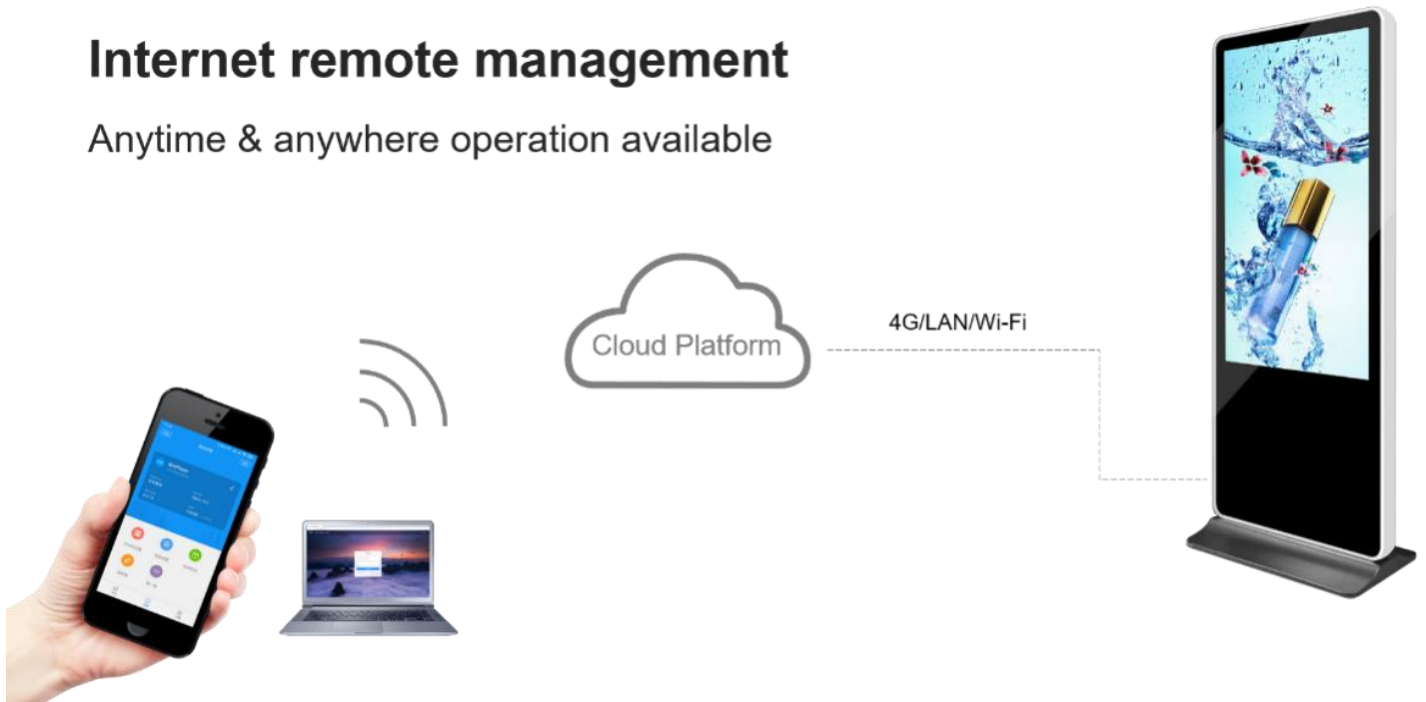

Chapter IV Appendix: Product Appearance

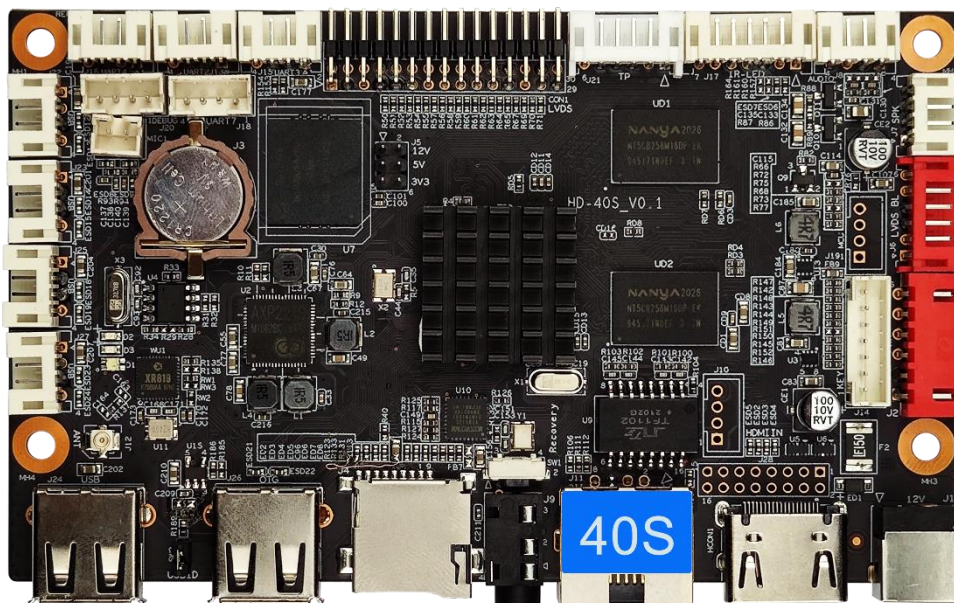

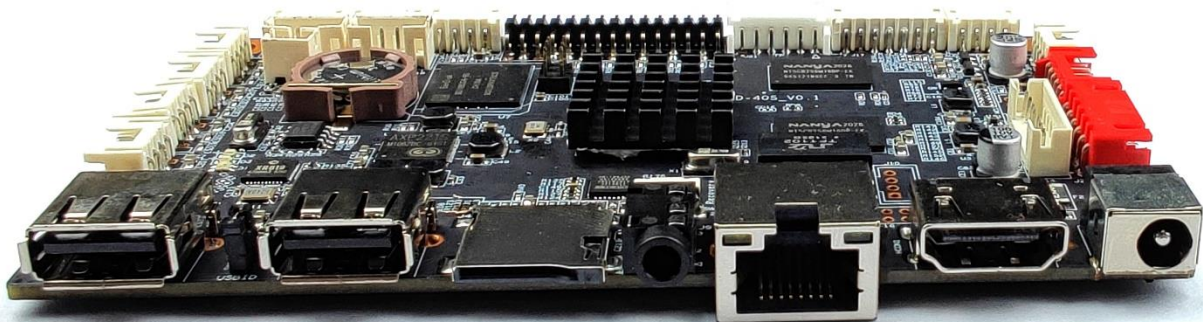
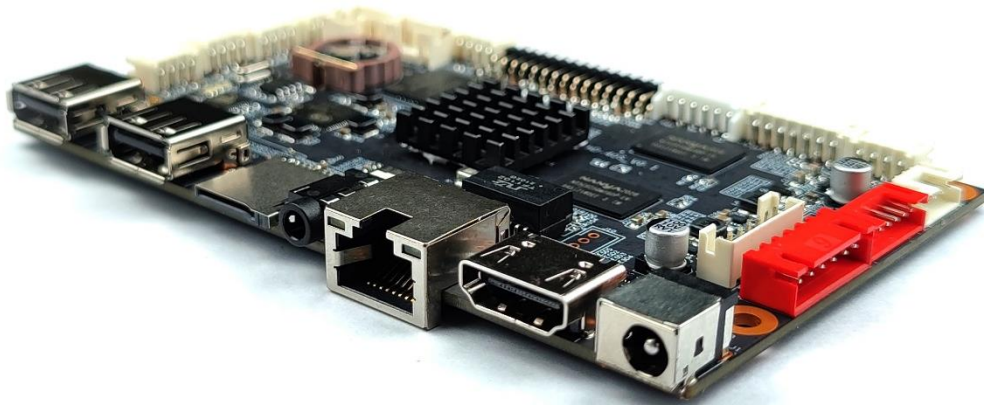

Note:

1. Paste the corresponding model label on the sales product. Some difference between the product picture in the specification and the actual product, not a fake or inferior product. If you have any questions, please contact HUIDU Technology for confirmation.